

# TOP LOAD WASHER

AWNA62  
TRADITIONAL



MADE IN AMERICA, BUILT TO LAST SINCE 1908



# PROVEN PERFORMANCE SINCE 1908

From Australian mines and oil rigs to the US Army, Speed Queen has over a century of experience performing in the harshest environments around the world, earning a reputation for reliability and performance.

With the toughest top loader in its class, and its matching dryer, you can get Speed Queen's uncompromising performance at home.

## DURABLE

Built to last up to 25 Years in the home or 10,400 cycles.

## TRUSTED

Over 100 years of experience manufacturing laundry equipment.

## QUALITY

Commercial grade industrial motor with stainless steel wash bowl.

## EFFICIENCY

Unique Flex Vane agitator with 68 strokes per min, the most efficient of wash cycles in just 35 minutes.

## TRADITIONAL

Quick and easy to use controls.

WASHER	AWNA62
Wash tub	Stainless Steel
Electrical Requirements	240V / 50Hz AC / 1 Ph
Breaker Size	10 Amp
Wash Cycles	8
WELS	3 Stars 7.5 kg



## MATCHING TRADITIONAL DRYER: ADE3TRW (ELECTRIC) AND ADG3TRW (GAS)

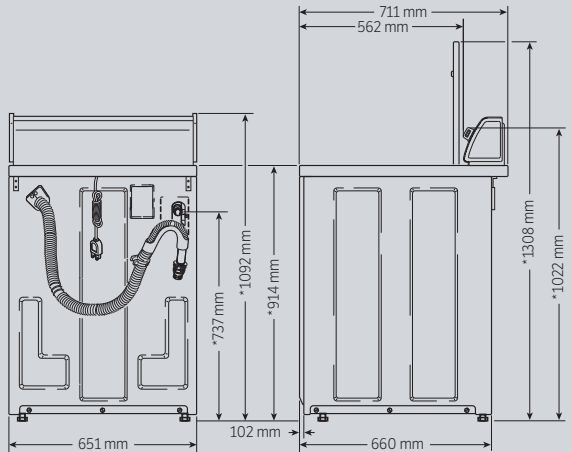

\*With leveling legs turned into base.

To learn more about Speed Queen's century of uncompromising performance and reliability, visit [speedqueen.co.nz](http://speedqueen.co.nz) or call 0800 77 333 7 today.

Five year warranty on all parts and labour. Lifetime parts warranty on the stainless steel wash tub and outer tub against rust and corrosion.

For the most accurate information, the installation guide should be used for all design and construction purposes. Due to continuous product improvements, design and specifications are subject to change without notice. The quality management system of Alliance Laundry Systems' Ripon facility has been registered to ISO 9001:2000.